

KLT-IRSW-OS05A20 V3.0

5MP OmniVision OS05A20 IR Switch MIPI-Schnittstelle M12 Fester Fokus Kameramodul

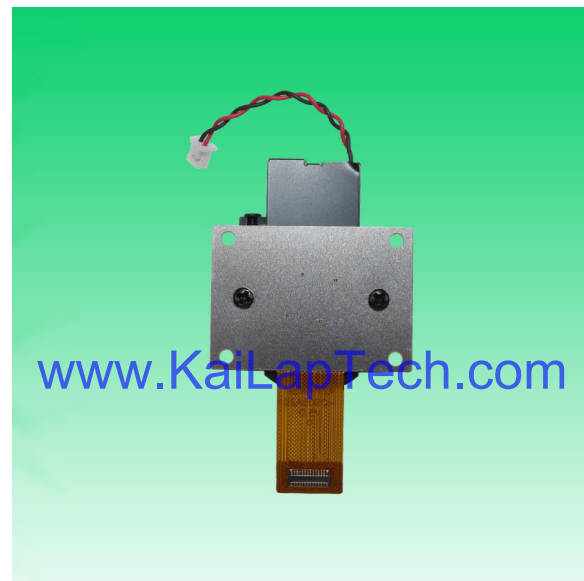

Auflösung	5MP
Bildsensor	OS05A20
Sensorart	1/2.7"
Pixel Größe	2.0 um x 2.0 um
EFL	1.95 mm
F.NO	2.20
Pixel	2688 x 1944
Betrachtungswinkel	180.0°(DFOV) 171.5°(HFOV) 118.0°(VFOV)
Linsenabmessungen	22.20 x 21.50 x 12.96 mm
Modulgröße	50.00 x 30.00 mm
Modultyp	Fester Fokus
Linsenmodell	KLT-LENS-E8335C
IR Switch Automatische Steuerung	3.3V - 5.5V
Linsenfilter IR-Frequenz	645nm +/- 15nm
Lens Filter AR-Frequenz	700nm - 1,000nm
Betrieb (IR-Tageszeit)	Rote Linie: Negativ Schwarze Linie: Positiv
Betrieb (bei Nacht)	Rote Linie: Positiv Schwarze Linie: Negativ
Anschluss für IR-Schalter	962-10231-030005 (2 Stift)
Schnittstelle	MIPI
Betriebstemperatur	-30°C to +85°C
Gegenstecker	WP7A-S024VA1

**KLT-IRSW-OS05A20 V3.0****5MP OmniVision OS05A20 IR Switch MIPI-Schnittstelle M12
Fester Fokus Kameramodul**

Ansicht von oben



Seitenansicht

www.KaiLapTech.comwww.KaiLapTech.com

Untersicht



Gegenstecker

ROHS

PIN SIGNAL

1	AGND
2	AVDD2.8V
3	SDA
4	SCL
5	PWDN
6	RST/XSHUNDN
7	MCP
8	MCN
9	DGND
10	MDP0
11	MDN0
12	DGND
13	MDP1
14	MDN1
15	DGND
16	MDP2
17	MDN2
18	DGND
19	MDP3
20	MDN3
21	DGND
22	DVDD1.2V
23	DVDD1.8V
24	MCLK

Parameter:

1. Sensor specification:

Image Sensor: OS05A20

Pixel: 2umx2um

Lens Type: 1/2.7

Important Voltage Description: DVDD1.2V

(external power supply);

2. Lens specification:

FOV: 180°(D),171.5°(H),118°(V)

F/NO: 2.2

OP distortion: <-9%

Focal length: 1.95mm

Composition: 6G+IR Switch

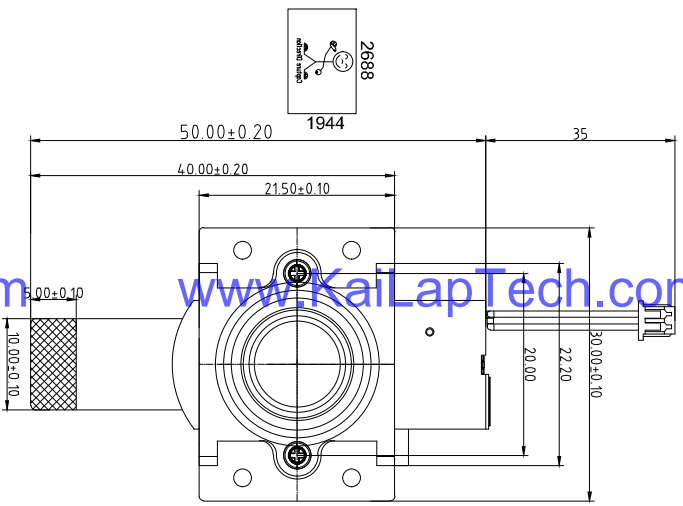

TOP VIEW

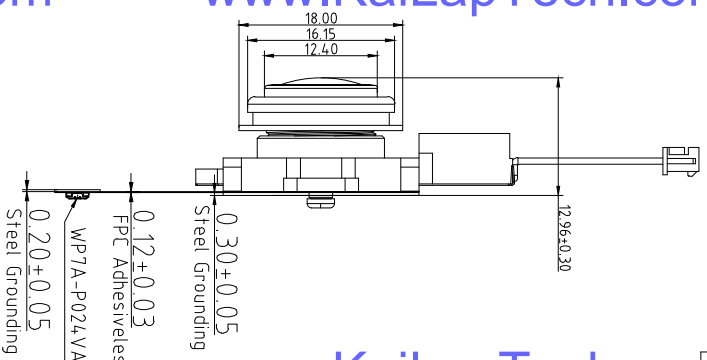

SIDE VIEW

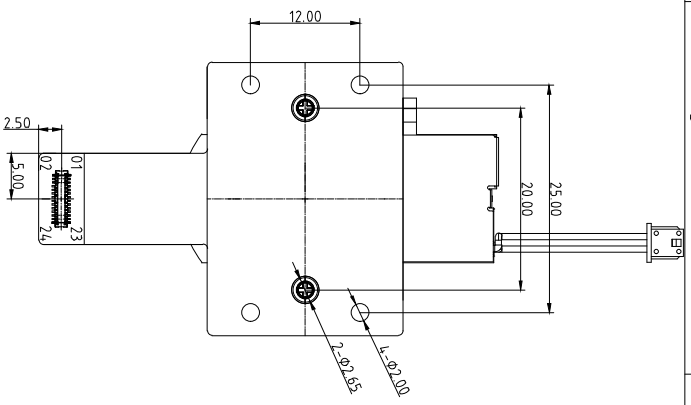

BOTTOM VIEW

NOTE:
1.The device slave
address:0x6C(w),0x6D(r)

Version Mark	Information	Date
V1.0	PD First Version	2019-03-23
V2.0	Connector changed	2019-03-23
V3.0	Change lens and IR CUT	2019-10-29

Kai Lap Technologies Group Ltd

Designed By

Kavin

Model Name:

KLT-IRSW-OS05A20 V3.0

Checked By

Aouly

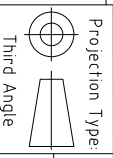

Unit: mm

Scale: 1:1

Sheet: 1 of 1

Version: 1/0

A

B

C

D

E

3

3

2

2

1

1



Lens Model: KLT-LENS-E3335C

SPECIFICATION SHEET	
Material No. 物料号	/
传感器规格 Sensor Spec	CCD/CMOS
最大像面 Max Image Circle	Ø5.6mm
EFL 有效焦距	1.95mm
F.No. F值	F2.2
	OS05A20
F.O.V. 视场角	D 对角 180°(5.57mm) H 水平 171.5°(5.376mm) V 垂直 118°(3.888mm)
Back Focal Length 后焦距	3.07mm (0.3mm filter +0.4 cover glass)
Lens Effective Diameter 有效口径	Front Ø9.4mm Back Ø6mm
Lens construction 镜头组成	6-5(A5G)
OP Distortion 光学畸变	-9%
Resolution 分辨率	Mega pixel
Relative Illumination 相对照度	>40%
Iris 光圈	Fixed
Max Chief Ray Angle 最大主光线入射角	15.6±3°
Mount 接口	M12X0.5
TTL 光学总长	12.2mm (0.3mm filter +0.4 cover glass)
Dimension (ØxL) 外形尺寸	Ø18x12.5
Filter Spec 滤光片规格	/

Image Circle vs. Sensor Format

REV. NO.	DATE	DESCRIPTION	DESIGNED	APPR.	CHECKED	APPR.	NAME	DATE
00	2019.6.30	新模作成	HLQ	XLL	AUDI.			

UNLESS TOLERANCE Single Part Size A31 | Portfolio Size A23 | 3RD Angle Projection

客户确认
签章处

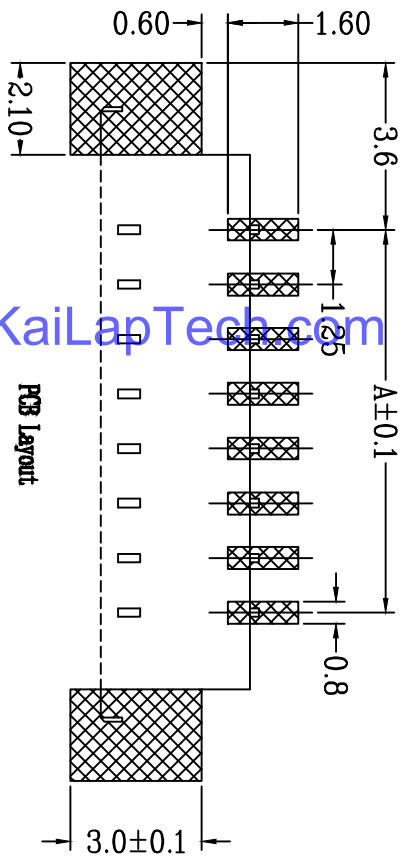
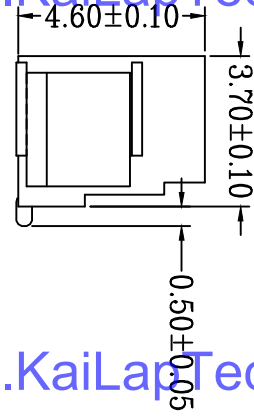
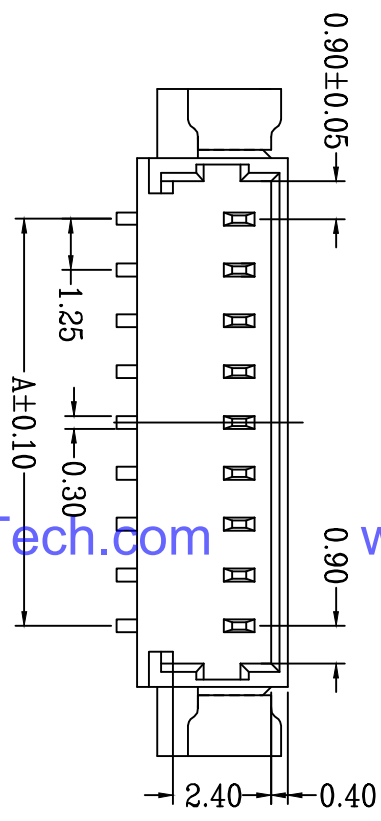
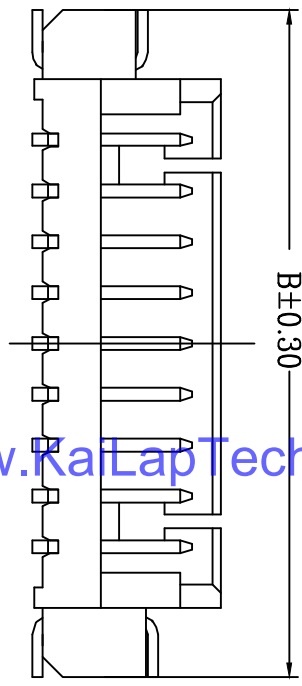

PIN	A	B
2	1.25	7.70
3	2.50	8.95
4	3.75	10.20
5	5.00	11.45
6	6.25	12.70
7	7.50	13.95
8	8.75	15.20
9	9.00	16.45
10	10.25	17.70
11	11.50	18.95
12	12.75	20.20
13	13.00	21.45
14	14.25	22.70
15	15.50	23.95
16	16.25	25.20

NOTES:
 Current Rating: 0.3A AC,DC
 Voltage Rating: 100V AC,DC
 Temperature Range: -25°C to +85°C
 Contact Resistance: 20mΩ Max
 Insulation Resistance: 100MΩ min
 Withstanding Voltage: 300V AC/minute
 PIN Material: phosphor bronze Tin plated
 Material: LCP UL94V-0 ROHS

www.KaiLapTech.com

www.KaiLapTech.com

www.KaiLapTech.com

www.KaiLapTech.com

		深圳市福金鹰电子有限公司 SHENZHEN FJY ELECTRONICS CO., LTD.		物料: 米色 环保料 立脚: 环保料	
TITLE	PH: 25mm	WIDE	090106-15	DATE	16/08/16
PART No.	962-10231-030005	DWG NO.	090106-15	CHECK	
SCALE	1:1	PROJ.	1/1	APPRO.	
TEL: (00)86-7553310/1/12		FAX: (00)86-7553300/13		E-MAIL: sales@kai.com	
		http://www.kai.com			

GENERAL TOLERANCE
 UNLESS OTHERWISE NOTED

±0.50	±16.00°
±0.38	±12.00°
±0.25	±11.00°
±0.15	±10.00°
Length	Angle

NEW



0.4mm Pitch, Stacking Type
Board-to-Board (FPC) Connector

CONNECTOR

MB-0228-3

September 2017

WP7 Series

RoHS Compliant

Plug

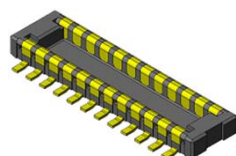

Plug

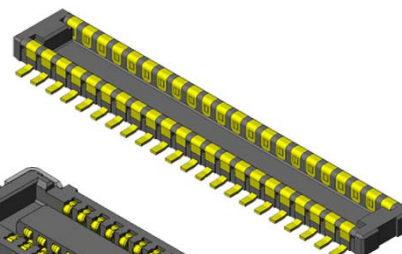

www.KaiLapTech.com

Receptacle

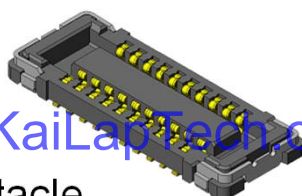

www.KaiLapTech.com

Receptacle

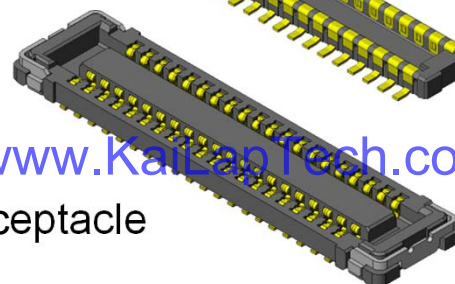

The WP7 Series is a low-profile board-to-board (FPC) connector with 0.4mm pitch spacing that is ideal for high-density mounting in slim information communication devices like mobile phones, smartphones, LCD, and notebook PC.

To satisfy different product function requirements, a low pin count type and a high pin count type (WP7A / WP7B) are available with the same mounting pattern.

Features

- 0.4mm pitch, 2 rows, 0.7mm stacking height.
- Contact structure ensures high wear-resistance and high contact reliability.
- Secure hold-downs prevent insulator breakage and peeling from FPC.
- 2-point contact design to resist twisting stress.
- Pb-free (Ni barrier on contact prevents solder wicking.)
- Receptacle contacts adopt an optimal configuration according to the pin counts.

High removal force WP7A (low pin count: 10-32 pos.)

Low insertion force WP7B (high pin count 34-70 pos.)

- Signal contact supports 10 Gbps transmission rate
- Supports MIPI, USB3.1 Gen2, and PCIe Gen3 transmission.

General Specifications

- | | |
|-----------------------------------------------------------------------------------------------------------------------------------------------------------------------------------------------------------------------------------------------------------------------------------------------------------------------------------------------------------------------------------|-------------------------------------------------------------------------------------------------------------------------------------------------------------------------------------------------------------------------------------------------------------------------------------------------------------------------------------------------------------------------------------------------------------------------------------------------------------------------------------------------------------------------------------------------------------------------------|
| <ul style="list-style-type: none"> ■(WP7A) No. of Contacts:
10, 16, 20, 22, 24, 26,
28, 30, 32 pos. ■(WP7B) No. of Contacts:
34, 40, 50, 60, 70 pos. ■Pitch: 0.4mm, 2 rows ■Operating Temperature:
-40 Deg. C to +85 Deg. C ■Contact Resistance:
70mΩ max. (initial) ■Life Time: 30 mating cycles | <ul style="list-style-type: none"> ■Rated Current: AC, DC 0.3A each per terminal ■Rated Voltage: AC, DC 50V ■Insulation Resistance: 100MΩ min. (initial) ■Dielectric Withstanding Voltage:
AC250Vr.m.s for 1 minute ■(WP7A) total insertion force:
1.50N x n max. (n: No. of pos.) ■(WP7A) total removal force:
0.15N x n min. (n: No. of pos.) ■(WP7B) total insertion force:
1.00N x n max. (n: No. of pos.) ■(WP7B) total removal force:
0.10N x n min. (n: No. of pos.) |
|-----------------------------------------------------------------------------------------------------------------------------------------------------------------------------------------------------------------------------------------------------------------------------------------------------------------------------------------------------------------------------------|-------------------------------------------------------------------------------------------------------------------------------------------------------------------------------------------------------------------------------------------------------------------------------------------------------------------------------------------------------------------------------------------------------------------------------------------------------------------------------------------------------------------------------------------------------------------------------|

Materials and Finishes

Component	Material / Finish
Contact	Cu alloy / Au plating
Insulator	Heat-resistant plastic
Hold-Down	Plug: Cu alloy / Au plating Receptacle: Cu alloy / Sn plating

Ordering Information (Plug)

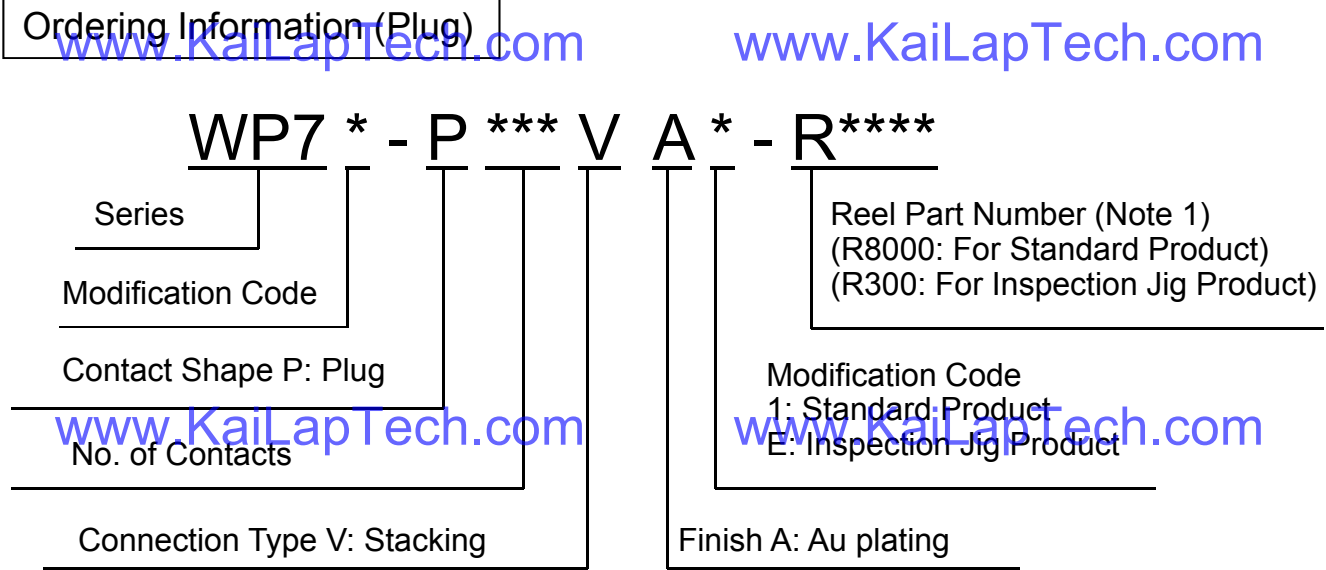

Ordering Information (Receptacle)

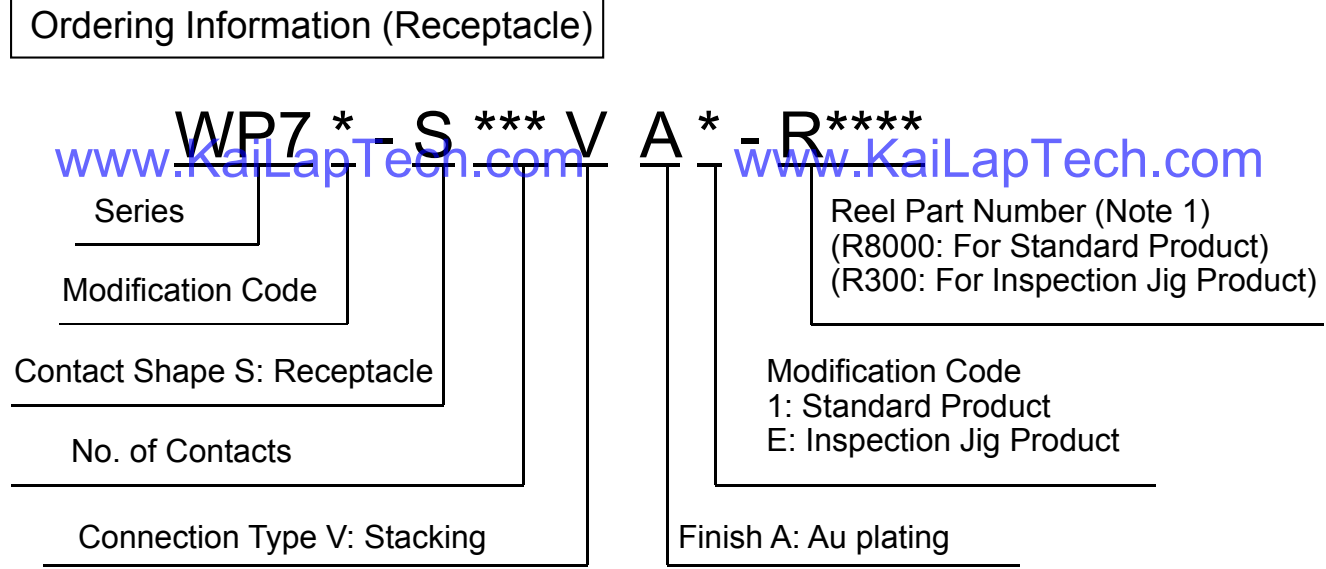

Note 1) An embossed tape reel contains 8,000 pieces of standard product, or 300 pieces of inspection jig product.
Please contact us for details on embossed tape specifications.

Part Number	WP7A-S***VA1
SJ Drawing	SJ111877

WP7A Receptacle

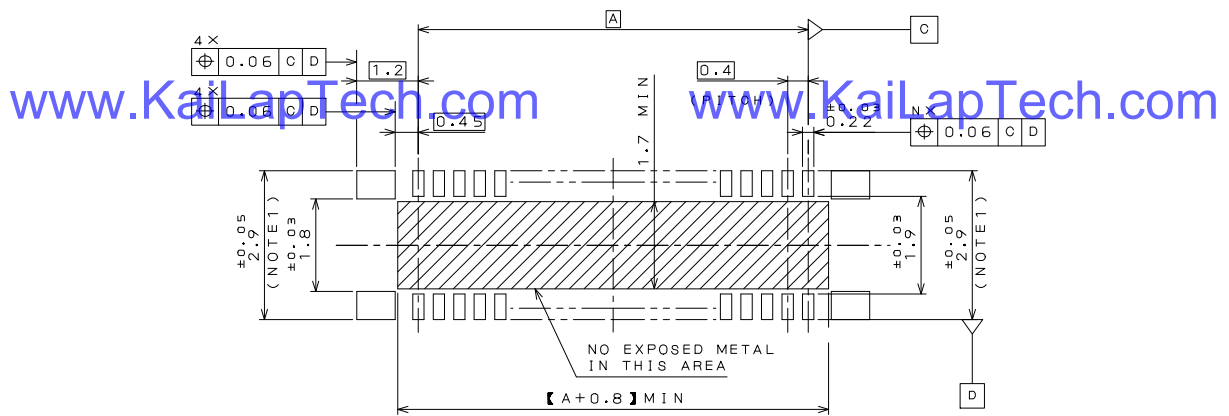
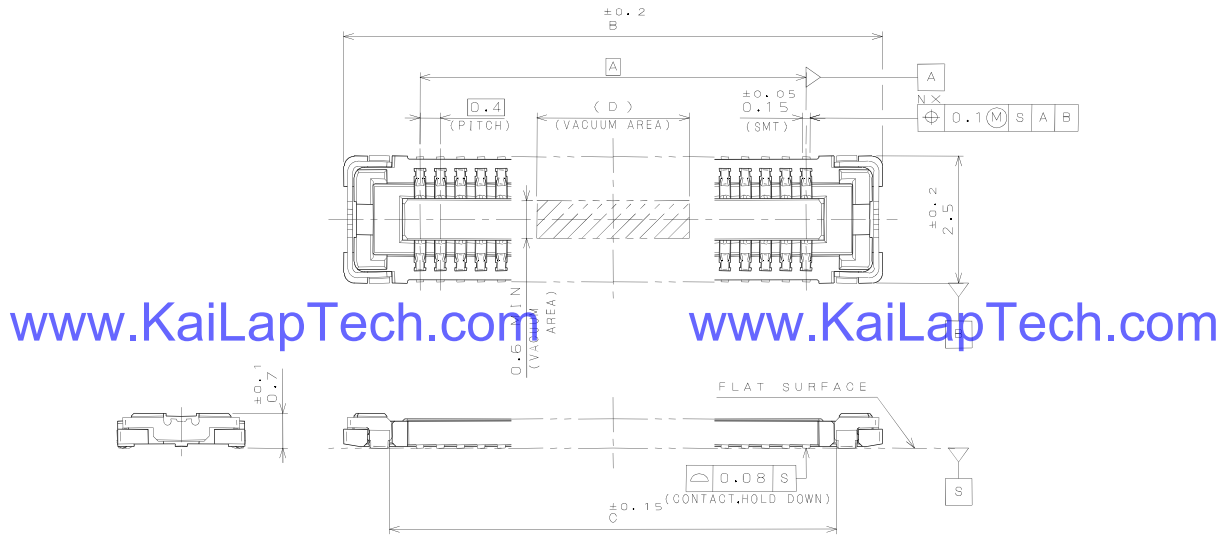

APPLICABLE P.C.B. DIMENSION (REF.)
適合基板寸法 (参考)

DIMENSIONS 寸法 NUMBER OF CONTACT 芯数	DIMENSIONS			
	A	B	C	D
10	1.6	4.6	2.8	2.0
16	2.8	5.8	4.0	2.0
20	3.6	6.6	4.8	2.0
22	4.0	7.0	5.2	2.0
24	4.4	7.4	5.6	2.0
26	4.8	7.8	6.0	5.0
28	5.2	8.2	6.4	5.0
30	5.6	8.6	6.8	5.0
32	6.0	9.0	7.2	5.0

Note 1) Dimension 3.5±0.05 is recommended in case repair is needed.

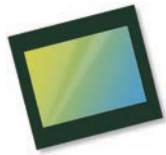

OS05A20 5-megapixel product brief

www.KaiLapTech.com www.KaiLapTech.com



www.KaiLapTech.com www.KaiLapTech.com

New OS05A20 Uses Nyxel® Technology to Bring Superior Image Quality to Video Surveillance Cameras



available in a lead-free package

www.KaiLapTech.com www.KaiLapTech.com

Day or Night

The 5-megapixel OS05A20 is the world's first image sensor to implement Nyxel® technology, OmniVision's breakthrough near-infrared (NIR) technology that allows image sensors to see better and farther under low- and no-light conditions. By using Nyxel® technology and a 2 x 2 micron pixel, the OS05A20 PureCel® image sensor has the unique ability to capture high-quality, high-resolution day or night, making it ideally suited for professional surveillance systems.

Nyxel® technology combines thick-silicon pixel architectures with extended deep trench isolation (DTI) to improve quantum efficiency (QE) up to 3x for 850 nm sensitivity and up to 5x for 940 nm sensitivity, while

maintaining all other image-quality metrics. These improvements deliver unrivaled image quality, extended image-detection range and a reduced light-source requirement, leading to lower power consumption.

Available in a 1/2.7-inch optical format, the OS05A20 is capable of capturing full-resolution 2688 x 1944 video at 60 frames per second (fps), 1080p full high definition (HD) video at 120 fps, and 720p HD video at 180 fps. The sensor comes in a chip scale package (CSP).

Find out more at www.ovt.com.



Applications

- Security Cameras
- High Resolution Consumer Cameras
- Action Cameras

Product Features

- 2 μm x 2 μm pixel
- optical size of 1/2.7"
- QE enhancement in 850 nm and 940 nm
- programmable controls for:
 - frame rate
 - mirror and flip
 - cropping
 - windowing
- supports output formats:
 - 12-/10-bit RAW RGB
- supports image sizes:
 - 2688 x 1944
 - 1080p (1920x1080)
 - 720p (1280x720)
- supports 2x2 binning
- standard serial SCCB interface
- 12/10-bit ADC
- up to 4-lane MIPI/LVDS serial output interface (supports maximum speed up to 1500 Mbps/lane)
- 2-exposure staggered HDR support
- programmable I/O drive capability
- light sensing mode (LSM)
- PLL with SCC support
- support for frame sync

OS05A20



Ordering Information

- OS05A20-H73A-1B (color, lead-free) 73-pin CSP
- OS05A20-H73A-1C (color, lead-free) 73-pin CSP

Technical Specifications

- active array size: 2688 x 1944
- maximum image transfer rate:
 - 2688 x 1944: 60 fps
 - 2688 x 1520: 60 fps
- power supply:
 - core: 1.2V
 - analog: 2.8V
 - I/O: 1.8V
- power requirements:
 - active: 210 mW
 - standby: 2 mA
 - XSHUTDOWN: 2 μA
- temperature range:
 - operating: -30°C to +85°C junction temperature
 - stable image: 0°C to +60°C junction temperature
- output formats: 10/12-bit RGB RAW
- lens size: 1/2.7"
- lens chief ray angle: 11° linear
- scan mode: progressive
- pixel size: 2.0 μm x 2.0 μm
- image area: 5434.56 μm x 3948.05 μm

Functional Block Diagram

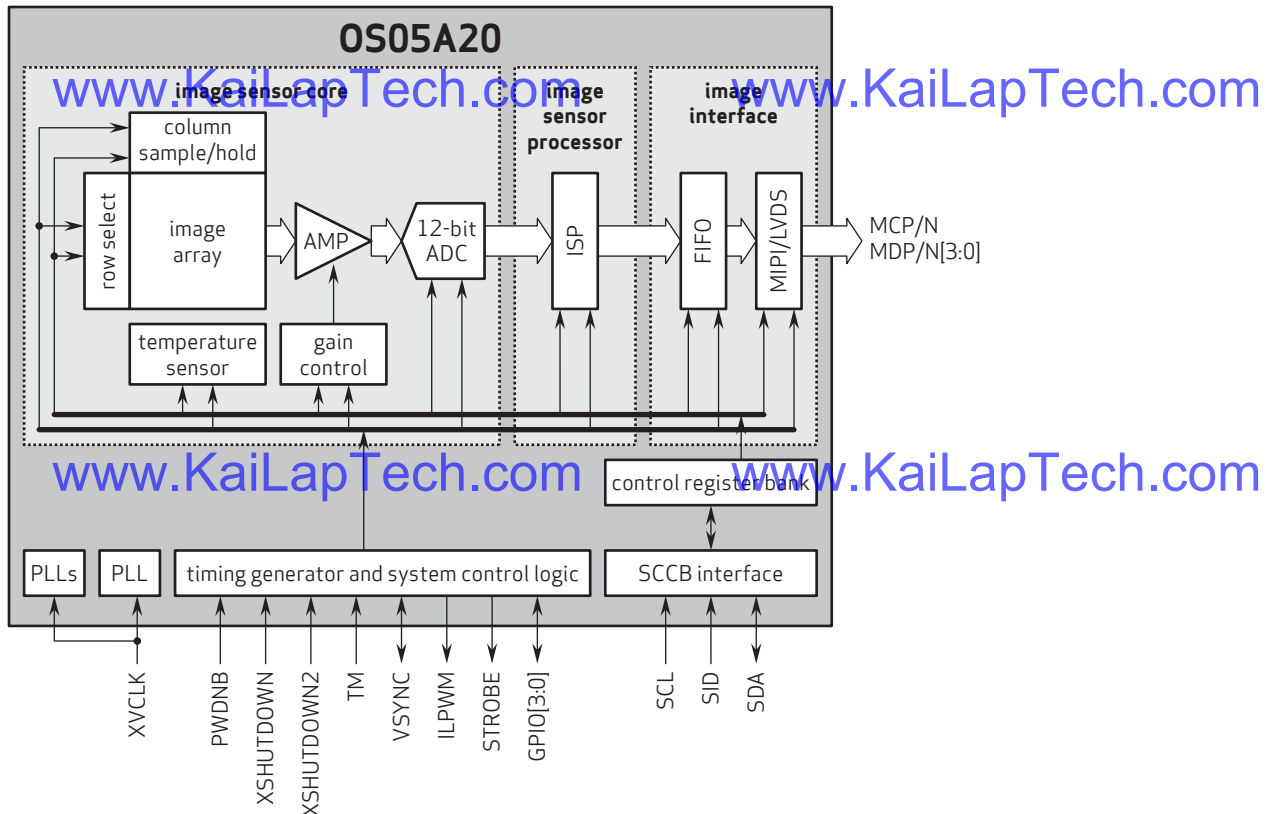

4275 Burton Drive
Santa Clara, CA 95054
USA

Tel: +1 408 567 3000
Fax: +1 408 567 3001
www.ovt.com

OmniVision reserves the right to make changes to their products or to discontinue any product or service without further notice. OmniVision, the OmniVision logo, PureCel, and Nixel are registered trademarks of OmniVision Technologies, Inc. All other trademarks are the property of their respective owners.



OmniVision



Referenztable für die Pinbelegungsdefinition des Kameramoduls

OmniVision Sony Himax Samsung On-Semi Aptina Himax GalaxyCore PixArt Bildsensoren	
Pin Signal	Beschreibung
DGND GND	Masse für digitale Schaltung
AGND	Masse für analoge Schaltung
PCLK DCK	DVP-PCLK-Ausgang
XCLR PWDN XSHUTDOWN STANDBY	Abschalten aktiv hoch mit internem Pulldown-Widerstand
MCLK XVCLK XCLK INCK	Systemeingangsuhr
RESET RST	Aktiv Low mit internem Pull-up-Widerstand zurücksetzen
NC NULL	keine Verbindung
SDA SIO_D SIOD	SCCB-Daten
SCL SIO_C SOIC	SCCB-Eingangstakt
VSYNC XVS FSYNC	DVP-VSYNC-Ausgang
HREF XHS	DVP-HREF-Ausgang
DOVDD	Strom für E/A-Schaltung
AFVDD	Strom für VCM-Schaltung
AVDD	Strom für analoge Schaltung
DVDD	Strom für digitale Schaltung
STROBE FSTROBE	Strobe-Ausgang
FSIN	Synchronisieren Sie das VSYNC-Signal vom anderen Sensor
SID	SCCB letzte Bit-ID-Eingabe
ILPWM	mechanische Shutter-Ausgangsanzeige
FREX	Rahmenbelichtung / mechanischer Verschluss
GPIO	Allzweckeingänge
SLASEL	I2C-Slave-Adresse auswählen
AFEN	CEN-Chip aktivieren aktiv hoch auf VCM-Treiber-IC
MIPI Schnittstelle	
MDN0 DN0 MD0N DATA_N DMO1N	MIPI 1st negative Ausgabe der Datenspur
MDP0 DP0 MD0P DATA_P DMO1P	MIPI 1st positiver Ausgang der Datenspur
MDN1 DN1 MD1N DATA2_N DMO2N	MIPI 2nd negative Ausgabe der Datenspur
MDP1 DP1 MD1P DATA2_P DMO2P	MIPI 2nd positiver Ausgang der Datenspur
MDN2 DN2 MD2N DATA3_N DMO3N	MIPI 3rd negative Ausgabe der Datenspur
MDP2 DP2 MD2P DATA3_P DMO3P	MIPI 3rd positiver Ausgang der Datenspur
MDN3 DN3 MD3N DATA4_N DMO4N	MIPI 4th negative Ausgabe der Datenspur
MDP3 DP3 MD3P DATA4_P DMO4P	MIPI 4th positiver Ausgang der Datenspur
MCN CLKN CLK_N DCKN	MIPI Uhr negativer Ausgang
MCP CLKP MCP_CLK_P DCKN	MIPI Takt positiver Ausgang
DVP Parallel Schnittstelle	
D0 DO0 Y0	DVP Datenausgabeport 0
D1 DO1 Y1	DVP Datenausgabeport 1
D2 DO2 Y2	DVP Datenausgabeport 2
D3 DO3 Y3	DVP Datenausgabeport 3
D4 DO4 Y4	DVP Datenausgabeport 4
D5 DO5 Y5	DVP Datenausgabeport 5
D6 DO6 Y6	DVP Datenausgabeport 6
D7 DO7 Y7	DVP Datenausgabeport 7
D8 DO8 Y8	DVP Datenausgabeport 8
D9 DO9 Y9	DVP Datenausgabeport 9
D10 DO10 Y10	DVP Datenausgabeport 10
D11 DO11 Y11	DVP Datenausgabeport 11



your **BEST** camera module partner

Kameraanwendungen



www.KaiLapTech.com

www.KaiLapTech.com

IMAGING DEVICES



www.KaiLapTech.com

www.KaiLapTech.com



www.KaiLapTech.com

www.KaiLapTech.com



Kamera-Zuverlässigkeitstest

Reliability Inspection Item		Testmethode	Akzeptanzkriterium	
Kategorie	Artikel			
Umwelt	Lager Temperatur	Hoch 60°C 96 Std	Temperaturkammer	Keine anormale Situation
		Niedrig -20°C 96 Std	Temperaturkammer	Keine anormale Situation
	Betriebs Temperatur	Hoch 60°C 24 Std	Temperaturkammer	Keine anormale Situation
		Niedrig -20°C 24 Std	Temperaturkammer	Keine anormale Situation
	Feuchtigkeit	60°C 80% 24 Std	Temperaturkammer	Keine anormale Situation
	Thermischer Schock	Hoch 60°C 0.5 Std Niedrig -20°C 0.5 Std Radfahren rein 24 Std	Temperaturkammer	Keine anormale Situation
Physisch	Falltest (Im freien Fall)	Ohne Verpackung 60cm	10 Mal auf Holzboden	Elektrisch funktionsfähig
		Mit Paket 60cm	10 Mal auf Holzboden	Elektrisch funktionsfähig
	Vibrations Test	50Hz X-Axis 2mm 30 Minuten	Vibrationstisch	Elektrisch funktionsfähig
		50Hz Y-Axis 2mm 30 Minuten	Vibrationstisch	Elektrisch funktionsfähig
		50Hz Z-Axis 2mm 30 Minuten	Vibrationstisch	Elektrisch funktionsfähig
	Zugfestigkeit des Kabels Krafttest	Gewicht laden 4 kg 60 Sekunden Radfahren rein 24 Std	Zugprüfmaschine	Elektrisch funktionsfähig
Elektrisch	ESD-Test	Kontaktaufnahme 2 KV	ESD-Prüfmaschine	Elektrisch funktionsfähig
		Luftentladung 4 KV	ESD-Prüfmaschine	Elektrisch funktionsfähig
	Alterungstest	On/Off 30 Sekunden Radfahren rein 24 Std	Stromschalter	Elektrisch funktionsfähig
	USB-Anschluss	On/Off 250 Mal	Einstecken und ausstecken	Elektrisch funktionsfähig





Inspektionsgegenstand		Untersuchungsmethode	Inspektionsstandard	
Kategorie	Artikel			
Aussehen	FPC oder PCB	Farbe	Das bloße Auge	Größere Unterschiede sind nicht zulässig.
		Zerrissen/gehackt werden	Das bloße Auge	Das Freilegen von Kupferrissen ist nicht zulässig.
		Markierung	Das bloße Auge	Klar, erkennbar (innerhalb von 30 cm Entfernung)
	Halterin	Kratzer	Das bloße Auge	Die Freilegung von Rissen im Inneren ist nicht zulässig
		Lücke	Das bloße Auge	Erfüllen Sie den Höhenstandard
		Schraube	Das bloße Auge	Stellen Sie sicher, dass Schrauben vorhanden sind (falls vorhanden)
		Schaden	Das bloße Auge	Die Freilegung von Rissen im Inneren ist nicht zulässig
	Linse	Kratzen	Das bloße Auge	Keine Auswirkung auf den Auflösungsstandard
		Kontamination	Das bloße Auge	Keine Auswirkung auf den Auflösungsstandard
		Ölfilm	Das bloße Auge	Keine Auswirkung auf den Auflösungsstandard
Abdeckband		Das bloße Auge	Kein Problem beim Aussehen.	
Funktion	Bild	Keine Kommunikation	Testboard	Nicht erlaubt
		Helles Pixel	Tafel	Im Image Center nicht erlaubt
		Dunkles Pixel	Weißer Tafel	Im Image Center nicht erlaubt
		Verschwommen	Das bloße Auge	Nicht erlaubt
		Kein Bild	Das bloße Auge	Nicht erlaubt
		Vertikale Linie	Das bloße Auge	Nicht erlaubt
		Horizontale Linie	Das bloße Auge	Nicht erlaubt
		Kleines Leck	Das bloße Auge	Nicht erlaubt
		Blinkendes Bild	Das bloße Auge	Nicht erlaubt
		Prellung	Inspektionslehre	Nicht erlaubt
		Auflösung	Diagramm	Folgt dem Diagrammstandard für ausgehende Inspektionen
		Farbe	Das bloße Auge	Kein Problem
		Lärm	Das bloße Auge	Nicht erlaubt
		Ecke dunkel	Das bloße Auge	Weniger als 100 x 100 Pixel
Farbauflösung	Das bloße Auge	Kein Problem		
Abmessungen	Höhe	Das bloße Auge	Befolgt Zulassungsdatenblatt	
	Breite	Das bloße Auge	Befolgt Zulassungsdatenblatt	
	Länge	Das bloße Auge	Befolgt Zulassungsdatenblatt	
	Gesamt	Das bloße Auge	Befolgt Zulassungsdatenblatt	



KLT-Paketlösungen

KLT Kameramodul



Komplett mit Linsenschutzfolie



Tablett mit Gitter und Raum



Legen Sie die Kameras auf das Tablett



Paketlösung für Kameramodule

Volles Tablett mit Cameras

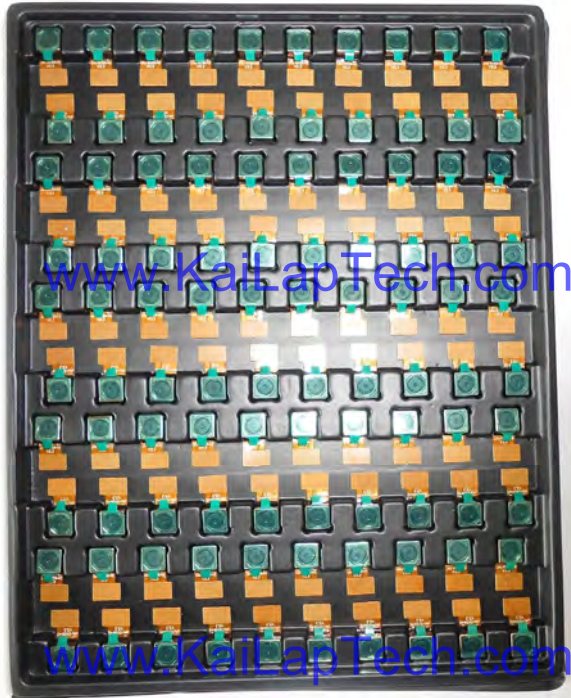

Abdeckschale mit Deckel



In Antistatikbeutel stecken



Staubsaugen Sie den antistatischen Beutel





Paketlösung für Kameramodule

Versiegelter Vakuumbbeutel mit Etiketten

1. Modell und Beschreibung 2. Menge 3. Versanddatum 4. Achtung





Paketlösung für große Bestellungen

Schaumstoffplatten zwischen
die Tablettts legen



Schaumstoffplatten sind etwas
größer als Tablettts



www.KaiLapTech.com

Legen Sie Schaumstoffplatten und
Tablettts in die Schachtel



www.KaiLapTech.com

Schaumstoffplatten sind eng anliegende Box



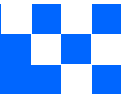

Paketlösung für kleine Bestellungen

Legen Sie die Schaumstoffplatten und
Tablets in die kleine Schachtel



www.KaiLapTech.com

Paket in kleiner Box für den Versand

Schaumstoffplatten passen gut in
die kleine Box



www.KaiLapTech.com

Legen Sie kleine Kartons in größere Kartons





your **BEST** camera module partner

Carbon Box Paketlösung

Verschließen Sie die Carbonbox

Beschriftete Schachtel mit Endverpackung



- Versandfertige Karbonbox**
1. Lieferadresse und Telefonnummer
 2. Box-Nr. und Versanddatum
 3. Zerbrechliche Vorsicht



Lösung für Musterbestellungspakete

Legen Sie die Probe in einen kleinen antistatischen Beutel



Stecken Sie die Anschlüsse in den kleinen antistatischen Beutel



Musteretiketten auf dem kleinen Beutel

1. Kameramodul oder Anschlussmodell 2. Lieferdatum und Menge 3. Achtung





Steckverbinder Paketlösung für große Bestellungen

Steckverbinder in einem Rad



Steckverbinder im Rad beschriftet



Das Rad passt perfekt in die Box



Steckerbox versandfertig



Unternehmen Kai Lap Technologies (KLT)

Kai Lap Technologies Group Limited. (KLT) wurde 2009 gegründet und ist ein technologiegetriebener Hersteller der nächsten Generation, der sich auf Forschung, Design und Produktion von Audio- und Videoprodukten spezialisiert hat. KLT verfügt über 20.000 Quadratfuß automatisierte Fabriken mit 100 Mitarbeitern und einem jährlichen Durchsatz von 30.000.000 Kameraeinheiten.

KLT bietet OEM-, ODM-Design, Auftragsfertigung und baut die Kameraprodukte. Sie können uns die Anforderungen auch mit einem Handentwurf übermitteln, unser Vertrieb und unsere Technik arbeiten zusammen, um Ihre Anforderungen zu erfüllen. Wir verstehen uns als Ihr langfristiger Partner bei der Entwicklung praktischer und innovativer Lösungen.

Unser Team deckt alles von der ersten Konzeptentwicklung bis zum Massenprodukt ab. KLT ist spezialisiert auf kundenspezifisches Kameradesign, Rohmaterial, Elektrotechnik, Firmware-/Softwareentwicklung, Produkttests und Verpackungsdesign. Unsere erfahrenen strategischen Versorgungssysteme bieten eine robuste und zuverlässige Fertigungskapazität für Aufträge unterschiedlicher Größe.

www.KaiLapTech.comwww.KaiLapTech.com**Eingeschränkte Garantie**

KLT gewährt die folgende eingeschränkte Garantie, wenn Sie das/die Produkt(e) direkt von der Firma KLT oder von der Website von KLT, www.KaiLapTech.com, gekauft haben. Produkte, die von anderen Verkäufern oder Quellen gekauft wurden, fallen nicht unter diese beschränkte Garantie. KLT garantiert, dass das/die Produkt(e) bei normalem Gebrauch für einen Zeitraum von einem (1) Jahr ab dem Datum, an dem Sie das Produkt erhalten („Garanzzeitraum“), frei von Material- und Verarbeitungsfehlern sind.

Für alle Produkte, die während des Garanzzeitraums Material- oder Verarbeitungsfehler enthalten oder entwickeln, wird KLT nach eigenem Ermessen entweder: (i) die Produkte reparieren; (ii) das/die Produkt(e) durch ein neues oder generalüberholtes Produkt(e) ersetzen (Ersatzprodukt(e) sind von identischem Modell oder funktionell gleichwertig); oder (iii) Ihnen den Preis erstatten, den Sie für das/die Produkt(e) gezahlt haben.

Diese eingeschränkte Garantie von KLT ist ausschließlich auf Reparatur und/oder Ersatz zu den oben genannten Bedingungen beschränkt. KLT ist nicht zuverlässig oder verantwortlich für nachfolgende Ereignisse.





your BEST camera module partner

KLT Stärke

Leistungsstarke Fabrik



Professioneller Service



Versprochene Lieferung

